

SERIES 249.40

SELF-PRIMING HORIZONTAL SCREW PUMP FOR NON LUBRICATING LIQUIDS



PRODUCTS

WATER

SEAWATER

OILS

HEAVY FUEL OILS

LIGHT PRODUCTS

LABELLING

BILGE/BALLAST PUMPS

GENERAL SERVICE PUMPS

CARGO PUMPS

TRANSFER PUMPS

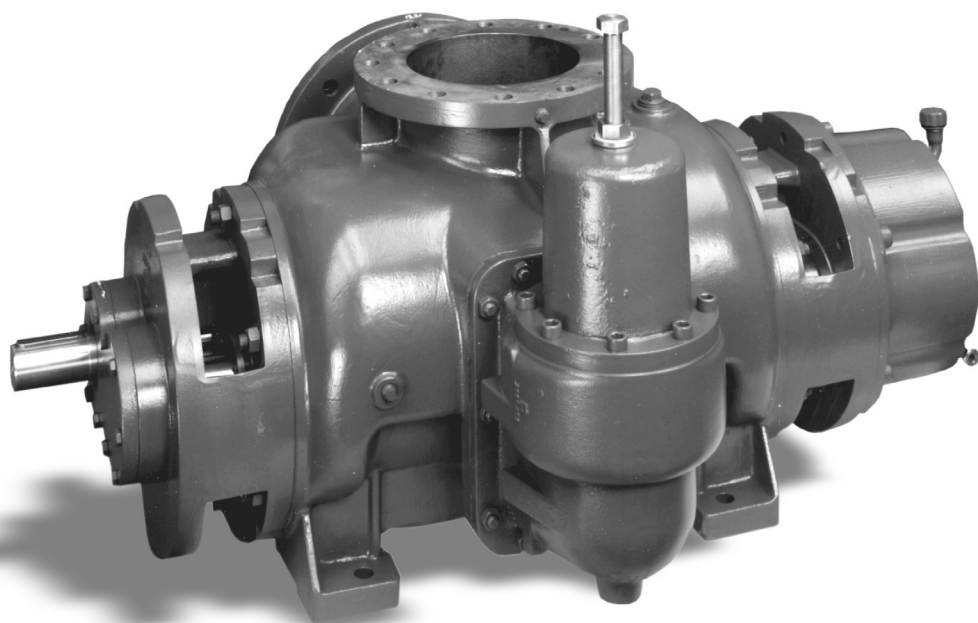

HOUTTUIN B.V.



Principle

The Houttuin double entry twin screw pumps series 249 are rotating self priming horizontal positive displacement pumps.

Two inter-meshing screws rotating in a pump casing ensure high pumping efficiency with constant axial flow and unequalled suction power.

Construction

The spindles are supported and axially held in position by ball bearings. The transmission of torque from the driven spindle to the idler spindle is effected by oil lubricated timing gears located outside of the pumping area in an attached gearbox. The ball bearings and timing gears maintain a small clearance between the screws, thus preventing metal to metal contact.

Shaft sealing

Single unbalanced mechanical seals keep the liquid to be pumped isolated from the bearings and the gearbox.

Overload protection

For protection against overload a built-on spring loaded relief valve can be supplied.

Applications

For pumping contaminated or slightly abrasive, lubricating and non-lubricating liquids of low or high viscosity which do not chemically attack the pump materials (corrosion proof materials can be offered).In the chemical and petro-chemical industry, soap and grease industry, paint and lacquer industry, food and beverage industry, plastics industry, sugar industry, environmental technology, in tank-farms and in the shipbuilding industry.

Products

- Water
- Seawater
- Oils
- Heavy fuel oils
- Light products

Labelling

- Bilge/ballast pumps
- General service pumps
- Cargo pumps
- Transfer pumps

Performance data

Capacity	Q	up to 2500 m ³ /h
Viscosity range	V	0,6 to 5000 cSt
Temperature of pumped liquid	t	up to 140 °C
Inlet pressure	p _s	up to 10 bar
Outlet pressure	p _d	up to 16 bar
Difference pressure	Δp	up to 16 bar
Speed	n	up to 1750 rpm
Flanges		according to DIN or ANSI

A preliminary pump selection can be effected by means of the performance graphs. For the exact performance data as function of the viscosity of the liquid to be pumped and the pump speed, please refer to the individual characteristics.

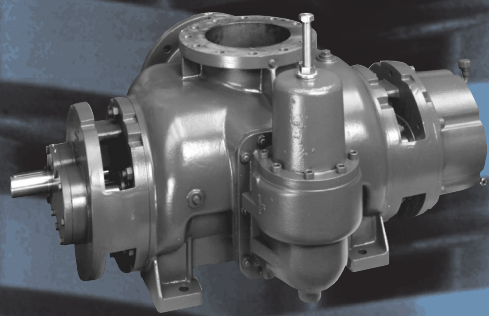

AVAILABLE MATERIALS

FOR PUMP AND MECHANICAL SEALS:

Pump			Mechanical seal according to DIN 24960 / API		
Screw shafts	Casing	Covers	Seal faces	Springs	'O' -rings
- Carbon Steel - Stainless Steel	- Cast Iron - Nodular Cast Iron - Cast Iron with coating - Carbon Steel - Stainless Steel	- Cast Iron - Cast Iron with coating - Carbon Steel - Stainless Steel	- Chrome Steel or Silicon Carbide against - Carbon	- Stainless Steel (Type 300)	- Viton - Teflon

Flow rate/pressure at minimum and maximum viscosity according to pump size.
 For exact performance data dependant of viscosity and rpm please refer to the individual characteristics per pump size.

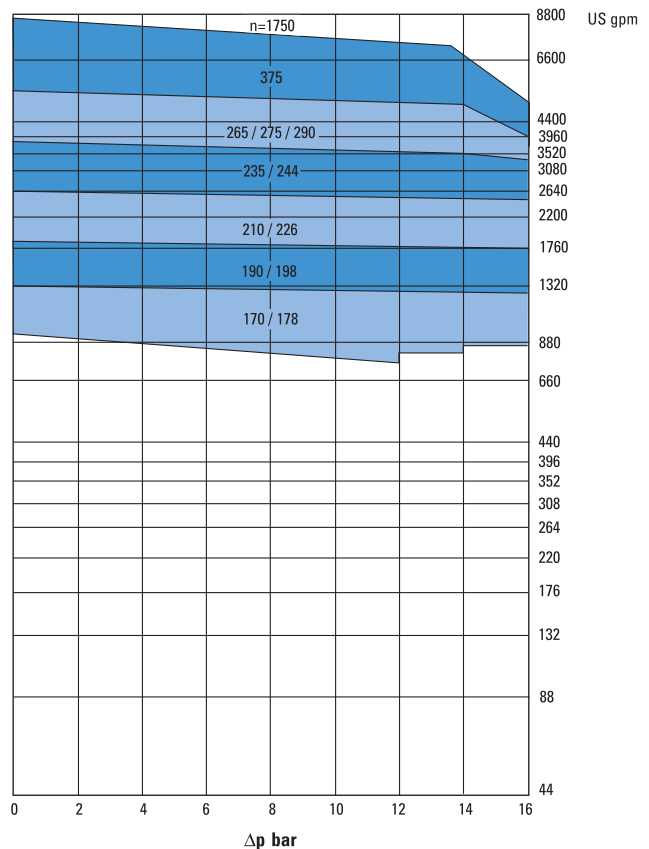
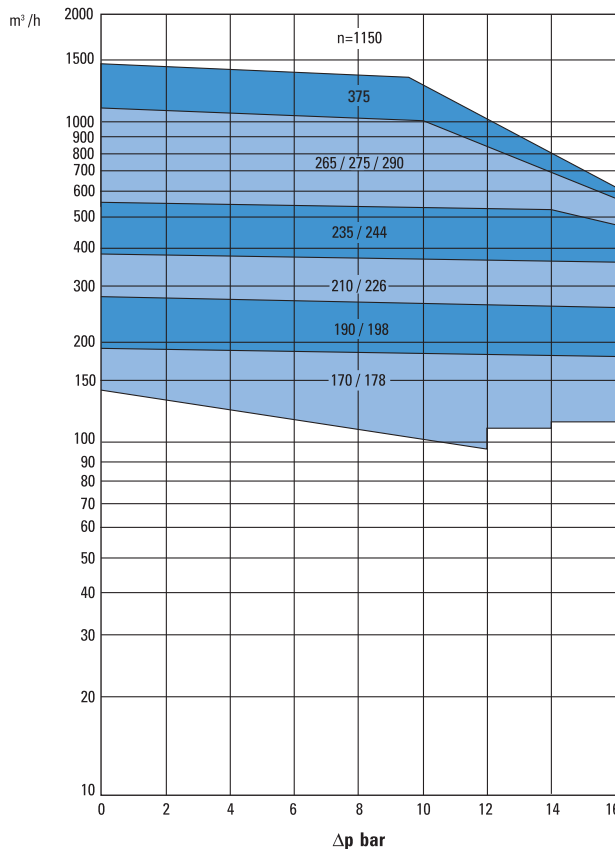
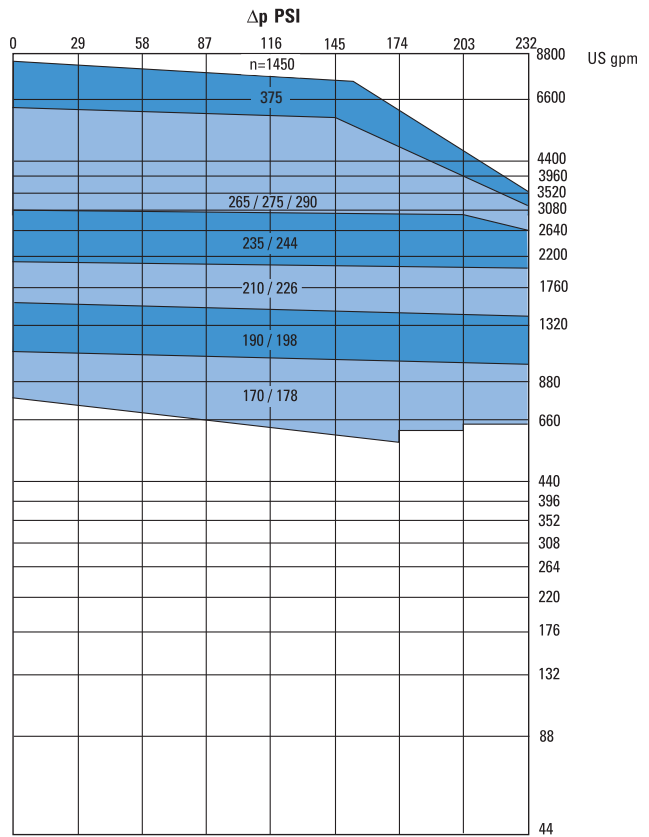
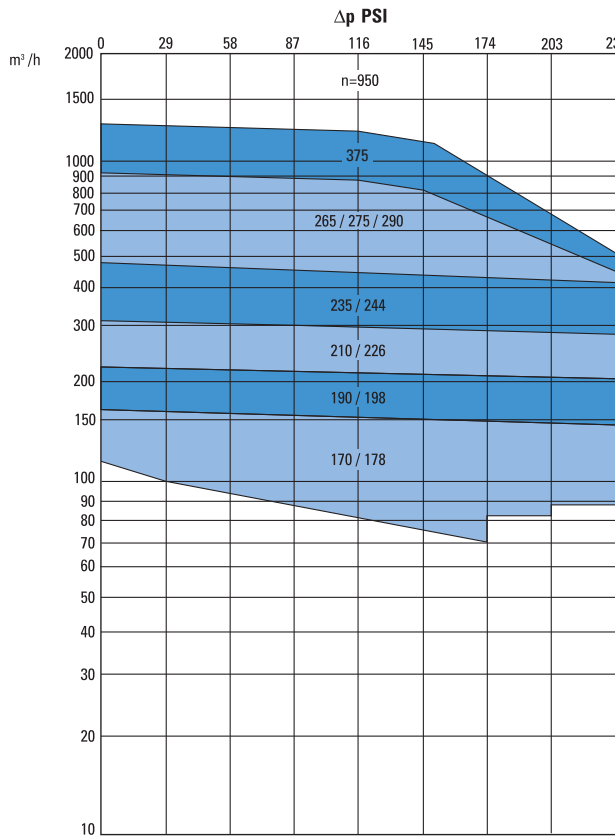

For **over load protection** a direct mounted pressure relief valve is optional

Heating of the pump foot is optional

Safe shaft sealing by single unbalanced and product lubricated mechanical seals.

Safe transmission of torque through the hardened and ground oil lubricated timing gears

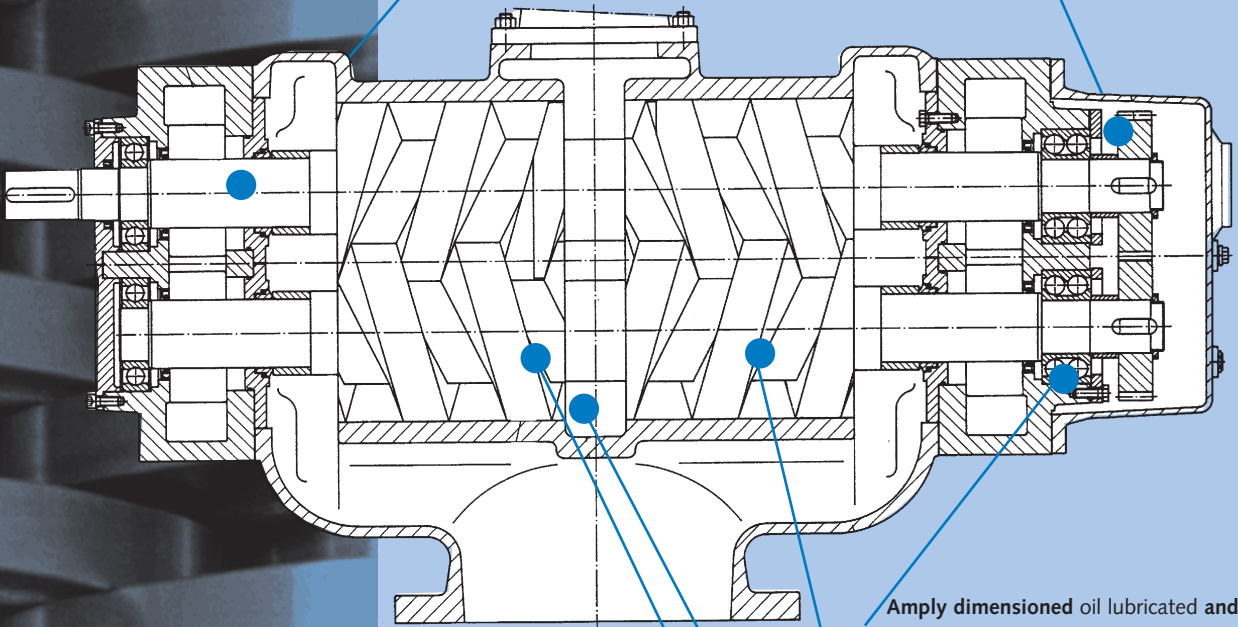

Amplly dimensioned oil lubricated and maintenance free ball bearings, which additionally serve for the axial location of the spindles.

The special profile of the spindle flanks results in **continuously and nearly pulsation-free pumping, high efficiency, good NPSH-values and constant pressure course.**

Axial forces balanced through double entry spindles

Rigid spindles of solid material therefore compared with multi-part spindles **no crevice corrosion.**

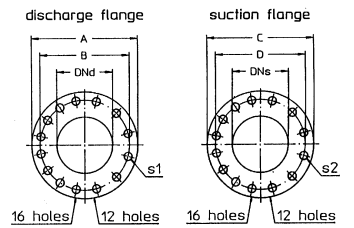
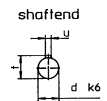
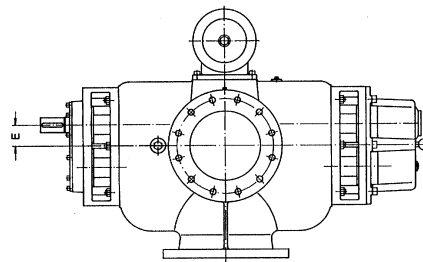
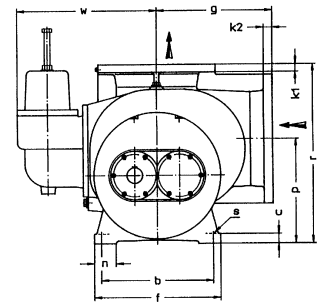
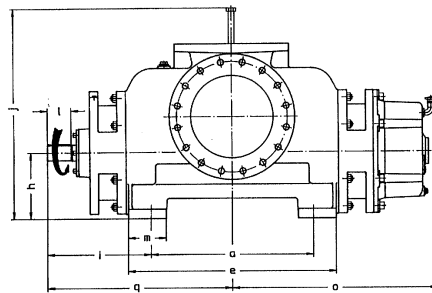

Sense of rotation: clockwise
seen from drive side

DIMENSIONS IN MM. DIMENSIONS ARE SUBJECT TO ALTERATIONS

pump size	pump foot dimensions									discharge flange PN 16 DIN 2533				suction flange 16 DIN 2533				
	a	b	c	e	f	m	n	s	DNd	A	B	k1	s1	DNc	C	D	k2	s2
170/178	460	335	40	580	380	90	60	4x22	200	343	295	30	12x22	250	405	355	32	12x26
190/198	495	390	40	640	450	120	80	4x26	200	343	295	30	12x22	250	405	355	32	12x26
210/226	520	415	40	670	475	120	80	4x26	250	405	355	32	12x26	300	483	410	32	12x26
235/244	620	460	40	880	520	160	90	4x26	300	483	410	32	12x26	350	533	470	36	16x26
265/275/290	970	500	45	1130	570	150	110	4x33	350	533	470	36	16x26	400	597	525	38	16x30
375	1070	560	50	1250	640	140	120	4x33	400	593	525	38	16x30	450	640	585	40	20x30

pump size	pump dimensions										shaft end				relief valve size	weight kg(ca)
	g	h	i	j	w	o	p	r	q	E	d	l	t	u		
170/178	315	200	370	610	475	700	280	505	600	67,5	50	75	53,5	14	100	600
190/198	375	225	392,5	800	545	740	315	560	640	75	55	75	59	16	135	720
210/226	415	250	415	815	565	755	340	620	675	82,5	60	100	64	18	135	890
235/244	475	280	470	930	580	870	430	740	780	92,5	65	100	69	18	135	1400
265/275/290	525	315	470	975	720	1020	485	835	955	100	80	140	79,5	20	160	2300
375	670	425	565	1050	835	1200	620	1020	1100	140	100	140	106	28	160	4000

dimensions in mm, dimensions are subject to alternations.

*) The diagrams show the performance range of the different pump series in our pump program and are for information only.

STANDARD PUMPS

With Internal Bearings

for lubricating liquids

viscosity range : 20 - 760 cSt
: 98 - 3500 SSU

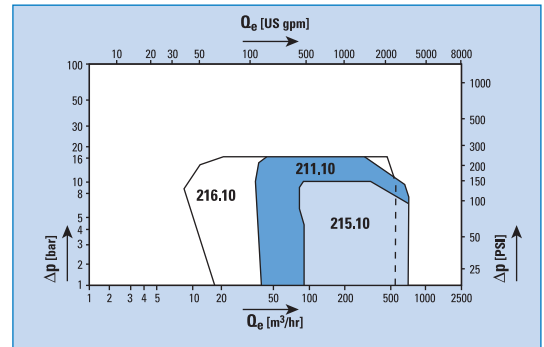

With External Bearings

for non-lubricating liquids

viscosity range : 0,6 - 1500 cSt
: 32 - 7000 SSU

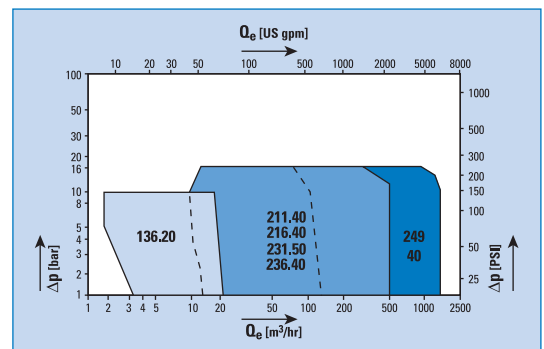

With External Bearings

for lubricating and non-lubricating liquids

viscosity range : 0,6 - 100.000 cSt
: 32 - 466.000 SSU

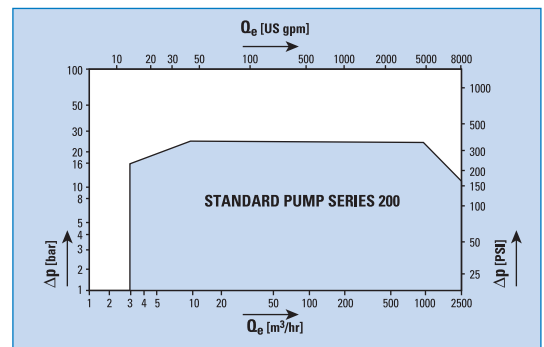

ENGINEERED PUMPS

With External Bearings

for lubricating and non-lubricating liquids

viscosity range : 0,6 - 100.000 cSt
: 32 - 466.000 SSU

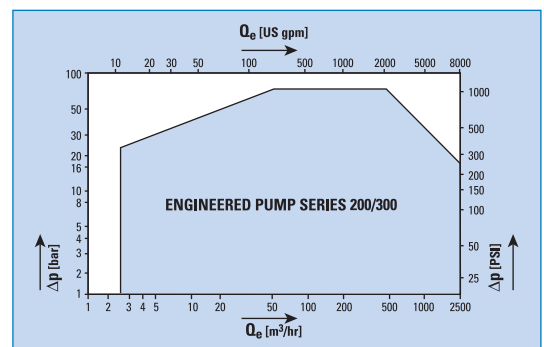

HOUTTUIN B.V.

Sophialaan 4, 3542 AR Utrecht
The Netherlands
P.O. Box 76, 3500 AB Utrecht
The Netherlands
Phone +31 - (0)30 - 2484611
Telefax +31 - (0)30 - 2411845
Telex 47280
Internet <http://www.circorpt.com>